

ecotecnico

technic

GRANITOGRES



**CASALGRANDE
PADANA**

THE GREEN WAY TO PAVE







COLORI | COLOURS | COULEURS | FARBEN

PAVIMENTI | FLOORS | REVÊTEMENT SOL | BODENFLIESEN



grigio cenere



bianco avorio

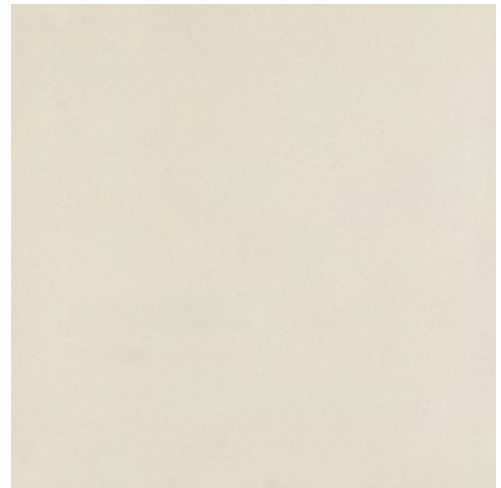

bianco B



nebraska



arkansas



ontario

ecotecnico

RIVESTIMENTI SMALTATI | GLAZED TILES | REVÊTEMENT ÉMAILLÉ | FLIESEN AUS GLASIERTEM FEINSTEINZEUG

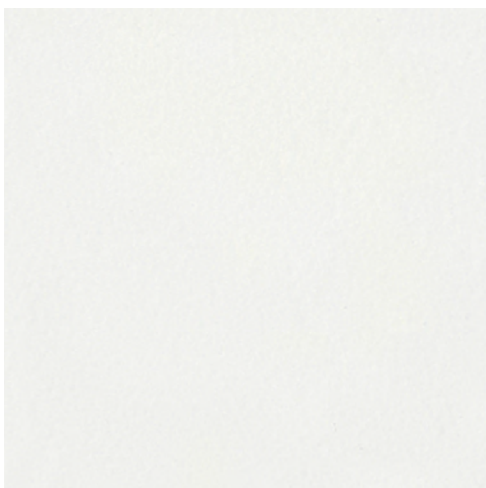

Landscape tundra 100 satin

SUPERFICI | SURFACES | SURFACES | OBERFLÄCHEN



technic R10



roccia R11 (A+B)



profil R12 - V8 (A+B+C)

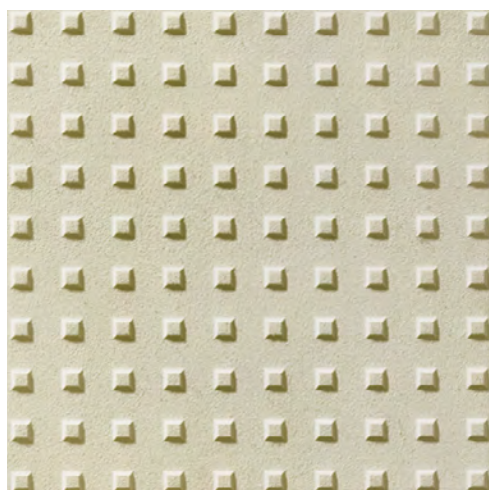

bugnato R11 - V6 (A+B+C)



reticolo R12 - V4 (A+B+C)



pavé R11 - V4 (A+B+C)





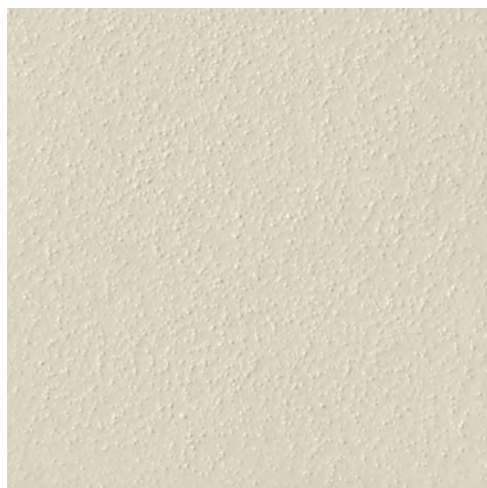







































secura R11 (A+B)











safe R12 (A+B+C)





FORMATI SPESSORI SUPERFICI | SIZES THICKNESSES SURFACES | FORMATS EPAISSEURS SURFACES | FORMATE SURFACES OBERFLÄCHEN

Caratteristiche tecniche Granitogres a pagina: Granitogres Technical features on page:
 Caractéristiques techniques Granitogres à la page : Granitogres Technische Eigenschaften auf Seite: 524

Formati Sizes Formats Formate	 cm 20x20 7 ^{7/8} "x7 ^{7/8} "	 cm 20x20 7 ^{7/8} "x7 ^{7/8} "	 cm 20x20 7 ^{7/8} "x7 ^{7/8} "	 cm 30x30 11 ^{3/4} "x11 ^{3/4} "	 cm 30x30 11 ^{3/4} "x11 ^{3/4} "	 cm 30x30 11 ^{3/4} "x11 ^{3/4} "
Spessori Thicknesses Epaisseurs Stärken	mm 8	mm 12	mm 14	mm 8	mm 11,2	mm 14
Granito 1 Arkansas						
Granito 1 Nebraska						
Granito 1 Ontario						
Unicolore Bianco Avorio						
Unicolore Bianco B						
Unicolore Grigio Genere						

-  Roccia **R11 A+B**
-  Secura **R11 A+B**
-  Bugnato **R11 A+B+C**
-  Technic **R10**
-  Profil **R12 A+B+C**
-  Reticolo **R12 A+B+C**
-  Pavé **R11 A+B+C**
-  Safe **R12 A+B+C**

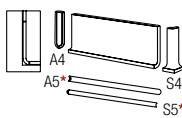
PEZZI SPECIALI | TRIMS | ACCESSOIRES | FORMSTÜCKE

				
Battiscopa Bullnose Plinthe à bord arrondi Stehsockel	Gradino Step tread Nez de marche Stufenplatte	Sguscetta Cove Gorge Rinneleiste	Zoccolo a raccordo a taglio retto Cove base - straight top Plinthe à gorge avec bord vif Hohlkehlsocbel (scharfkantig)	Zoccolo ad appoggio smussato Sit-on skirting - bevelled top Plinthe à talon avec bord arrondi Aufsetzsockel mit abgerundeter Kante
cm 9x30 3 ^{1/2} "x11 ^{3/4} "	cm 30x30 11 ^{3/4} "x11 ^{3/4} "	cm 4x20 1 ^{5/8} "x7 ^{7/8} "	cm 10x20 4"x7 ^{7/8} "	cm 10x20 4"x7 ^{7/8} "
cm 10x20 4"x7 ^{7/8} "				

PEZZI SPECIALI | TRIMS | ACCESSOIRES | FORMSTÜCKE

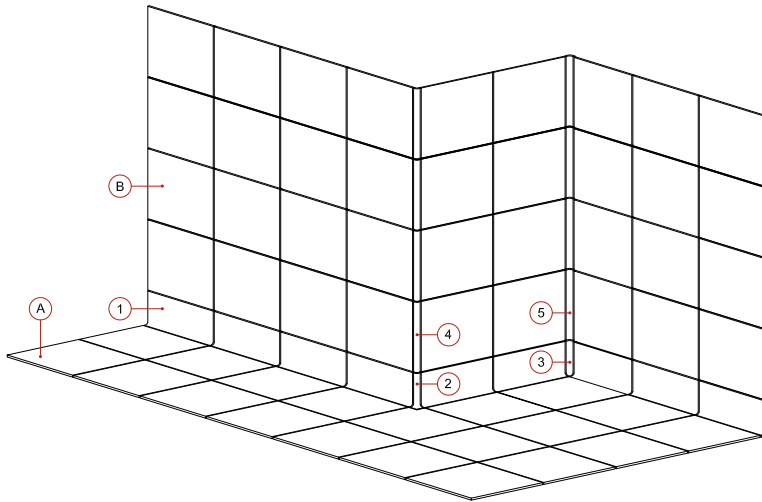

schema A

A pavimento formato cm 20x20 floor size cm 20x20
sol format cm 20x20 boden format cm 20x20

B rivestimento formato cm 20x20 wall tiling size cm 20x20
revetement format cm 20x20 wände format cm 20x20

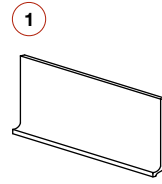

art. zoccolo a raccordo
cm 10x20 - 4"x7^{7/8}"



art. S4
cm 2,5x10 - 1"x4"

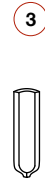

art. A4
cm 2,5x10 - 1"x4"

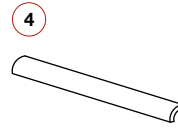

art. S5 sguscetta picc.
cm 2,5x20 - 1"x7^{7/8}"

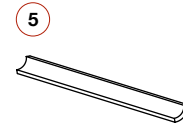

art. A5 sguscetta picc.
cm 2,5x20 - 1"x7^{7/8}"

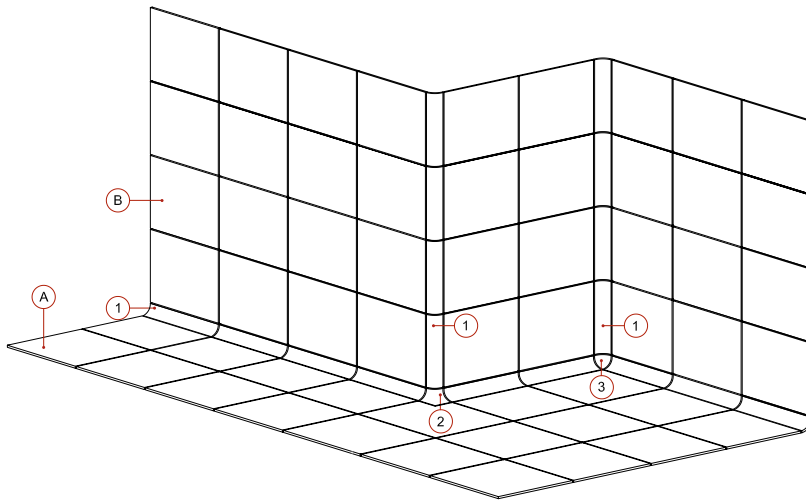

schema B

A pavimento formato cm 20x20 floor size cm 20x20
sol format cm 20x20 boden format cm 20x20

B rivestimento formato cm 20x20 wall tiling size cm 20x20
revetement format cm 20x20 wände format cm 20x20

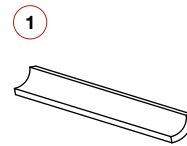

art. sguscetta
cm 4x20 - 1^{9/16}"x7^{7/8}"

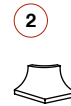

art. S1 piè d'oca
cm 5x7 - 2"x2^{3/4}"



art. A1 conchiglia
cm 5x5 - 2"x2"

PEZZI SPECIALI | TRIMS | ACCESSOIRES | FORMSTÜCKE

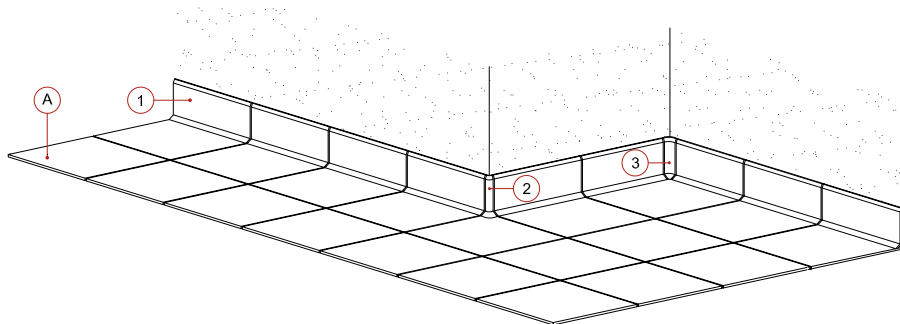

schema C

A pavimento formato cm 20x20 floor size cm 20x20
sol format cm 20x20 boden format cm 20x20

1

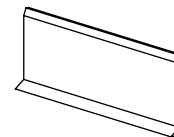

art. zoccolo ad appoggio
cm 10x20 - 4"x7^{7/8}"

2



art. S6
cm 2,5x10 - 1"x4"

3



art. A6
cm 2,5x10 - 1"x4"

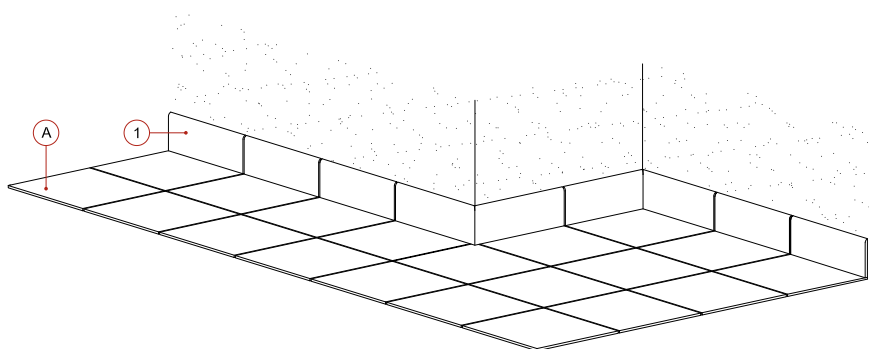

schema D

A pavimento formato cm 20x20 o cm 30x30 floor size cm 20x20 or cm 30x30
sol format cm 20x20 or cm 30x30 boden format cm 20x20 oder cm 30x30

1

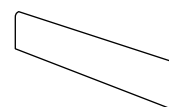

art. battiscopa
cm 10x20 - 4"x7^{7/8}"
cm 9x30 - 3^{1/2}"x11^{3/4}"













CARATTERISTICHE TECNICHE TECHNICAL FEATURES

CARACTÉRISTIQUES TECHNIQUES TECHNISCHE EIGENSCHAFTEN



norma
standards
norme
Norm

risultato prova*
test results*
resultats des essais*
Ergebnisse*

	classificazione prodotto product classification classement Klassifizierung	UNI EN 14411-G ISO 13006	gruppo Bla UGL completamente greificato group Bla UGL fully vitrified group Bla UGL grès cérame fin Gruppe Bla UGL Feinsteinzeug
	caratteristiche dimensionali e d'aspetto dimensional and surface quality caractéristiques de la surface Oberflächenqualität	UNI EN ISO 10545-2	tolleranze minime nella 1ª scelta very low tolerance des tolérances minimales en 1er choix Entspricht Normen
	assorbimento di acqua water absorption absorption d'eau Wasseraufnahme	UNI EN ISO 10545-3	< 0,1%
	resistenza alla flessione flexural strength résistance à la flexion Biegezugfestigkeit	UNI EN ISO 10545-4	45 N/mm ²
	resistenza al gelo frost resistance résistance au gel Frostwiderstandsfähigkeit	qualsiasi norma all standards toute norme alle normen	garantita guaranteed garantie Garantiert
	resistenza attacco chimico (esclusione acido fluoridrico) resistance to acids and alkalis (with the exception of hydrofluoric acid) résistance à l'attaque chimique (exclusion de l'acide fluorhydrique) Säure und Laugen Beständigkeit (mit Ausnahme von Fluorwasserstoff)	UNI EN ISO 10545-13	A
	resistenza usura e abrasione wear and abrasion resistance résistance à l'usure et abrasion Abriebhärte	UNI EN ISO 10545-6	≤ 150 mm ³
	dilatazione termica lineare linear thermal expansion coefficient linéaire de dilatation thermique Lineare Wärmeausdehnung	UNI EN ISO 10545-8	6 x 10 ⁻⁶
	resistenza alle macchie stain resistance résistance aux taches Fleckenfestigkeit	UNI EN ISO 10545-14	4 - 5 garantita guaranteed garantie Garantiert
	resistenza alla scivolosità (Superficie Naturale) slip resistance (Matt surface) résistance au glissement (Surface naturelle) Trittsicherheit (Natur Oberflächen)	DIN EN 16165 ANNEX B - ANNEX A	Roccia R11 A+B Secura R11 A+B Bugnato R11 A+B+C Technic R10 Profil R12 A+B+C Pavé R11 A+B+C Safe R12 A+B+C Reticolo R12 A+B+C
	resistenza dei colori alla luce colour resistance to sunlight exposure résistance de la couleur à la lumière Unveränderlichkeit der Farben wenn Strahlung zugesetzt wird	D.M. N° 236 DEL 14.06.89 METODO B.C.R.	valore $\mu > 0,40$
	resistenza dei colori alla luce colour resistance to sunlight exposure résistance de la couleur à la lumière Unveränderlichkeit der Farben wenn Strahlung zugesetzt wird	DIN 51094	nessuna variazione no change of colours couleurs inchangées Keinerlei Farbänderung

* valore indicativo approx value donnée approximative Ungefähre Werte

** si rimanda all'elenco prodotti UPEC ufficiale, consultabile sul sito: please see the official UPEC product list:

veuillez consulter la liste officielle produits UPEC: sihe die offizielle UPEC-Produktliste auf der Website: <http://evaluation.cstb.fr>

Al pari dei materiali naturali di riferimento, l'aspetto estetico, la differenza di tono e le venature possono essere diverse da piastrella a piastrella. Per una corretta comprensione della variabilità del prodotto è consigliabile prendere visione delle immagini a tutto ambiente sul catalogo di collezione, sul nostro sito all'indirizzo www.casalgrandepadana.it o chiedere maggiori informazioni ai nostri concessionari.

Just like the natural materials they are inspired by, the aesthetics, colouration and veining of the tiles can differ. To properly gauge the suitability of a product, we advise that you view the full-space photos that you can find in our collection catalogue and on our website at www.casalgrandepadana.com. Alternatively, please ask a reseller for more information.

Tout comme pour les matières naturelles de référence, la différence de tonalité, les veines ainsi que l'aspect esthétique peuvent varier d'une dalle à l'autre. Pour bien comprendre la variabilité du produit, il est conseillé de consulter les images d'ambiance présentes sur le catalogue de la collection, sur notre site à l'adresse www.casalgrandepadana.fr ou de demander plus d'informations à nos concessionnaires.

Wie bei den als Vorbild dienenden Naturmaterialien können sich auch hier das ästhetische Erscheinungsbild, der Farbtonunterschied und die Maserung von Fliese zu Fliese unterscheiden. Um die Variabilität des Produkts besser zu verstehen, raten wir Ihnen, die Bilder mit ausgestatteten Räumen im Kollektionskatalog auf unserer Website www.casalgrandepadana.de zu konsultieren. Weitere Informationen können Sie auch bei unseren Vertragshändlern erhalten.



**CASALGRANDE
PADANA**
THE GREEN WAY TO PAVE

via Statale 467, n. 73 - 42013 Casalgrande (Re) Italy
tel + 39 0522 9901 - fax + 39 0522 996121
info@casalgrandepadana.it - www.casalgrandepadana.com

